

Owner's Guide



David H. Levy Comet Hunter™ 152mm f/4.8 Maksutov-Newtonian Telescope

EXPLORE™
SCIENTIFIC

SUN WARNING

Do not use this telescope, or its finder scope to look at or near the Sun! Even momentary visual contact with the Sun's light rays can cause instant and irreversible damage to your eye(s). Eye damage can be painless, so there is no warning to the observer that damage has occurred until it is too late.

Take extra care when using the telescope during daylight hours, and do not point the telescope at or near the Sun. Do not look through the telescope or finder scope when you are moving the telescope during the daytime.

Never allow anyone to use the telescope during the daytime without warning them of the hazards of aiming at or near the Sun. Make sure that they are adequately trained on the use of this instrument before allowing them to start observations. Children should always have informed and trained adult supervision while observing.

MOVING AND LIFTING

Although the David H. Levy Comet Hunter Telescope is considered a lightweight instrument in its aperture class (about 15 pounds for just the telescope, and about 40 pounds with the telescope in its case), special care should be taken to make sure that you are not straining to lift or move it. Improper lifting and moving techniques can result in back injury and strained muscles.

Often astronomers work at night or in poorly lit conditions, so extra care must be employed. Whenever possible use two or more people to move or lift astronomical gear, or use a cart, dolly or other platform to make movement safe and easy.

When lifting the Comet Hunter telescope from its case, use the handle provided from the cradle ring and gently pull the instrument until it is free from the foam padding of the case. Double check to make sure that the cradle ring lock knobs are secured before lifting the instrument to place on a mount.

If you feel that the weight, shape, or size of any instrument makes the job too much for one person, ask for help.

Whenever possible make use of equipment to help lift and carry heavy gear; hoists, carts, and dollies are made for this purpose.

WARRANTY AND SERVICE

Product Warranty

Explore Scientific will repair or replace the product, or part thereof, found upon inspection to be defective, provided the defective part or product is returned to Explore Scientific USA, freight prepaid, with confirmation of product registration for a period of five years from the date of original purchase. Explore Scientific products purchased from the USA outside the United States are included in this extended warranty, but the owner is responsible for all shipping costs (including customs, taxes, etc.), both inbound to our USA facilities and outbound to the respective country that the product would be returned to.

Explore Scientific products purchased in other countries are covered under separate warranties issued by Explore Scientific International Distributors.

RMA Number Required

Prior to the return of any product or part, a Return Merchandise Authorization (RMA) number must be obtained by writing to Explore Scientific's Customer Service Department or by calling 1-888-599-7597, and we will be happy to provide you with return shipping instructions.

A Special Message from David Levy

My journey in astronomy started when I was a child attending summer camp, when I saw a meteor streaking across the night sky. Later when attending school we were asked to create an essay on the subject of what we were to do with our lives; I wrote that I wanted to become an astronomer who searched for comets. My teacher told me that my essay was fine, but that it would be impossible to make a living searching for comets. I put the idea into my mind where it grew, and finally blossomed in 1960; from that moment I knew I wanted a telescope.

Astronomical exploration and discovery is a personal quest for every astronomer, professional or amateur. And I can tell you from experience that it is no less thrilling to see the Rings of Saturn for the first time, as it is to discover a new comet. Although I never took a class in astronomy, over the years I have spent untold thousands of hours searching for comets, and to date, I have discovered or co-discovered 22 of them, including Comet Shoemaker-Levy 9 that crashed into Jupiter in 1994. My observations started with a small Newtonian reflector that I affectionately named Echo. As my interests intensified I obtained many telescopes, all of which I use today. To me, a telescope is much more than just a piece of equipment; it becomes an extension of me as I explore the stars.

The Comet Hunter telescope was an idea that started years ago when my friend Scott Roberts and I started a dialog about what kind of telescope would be best for someone who was just getting started to seriously follow their passion to explore the stars. I told Scott that in order for the telescope to be successfully used for searching for comets that it had to have a very wide field of view or what is called "rich field", capable of viewing two or more degrees true field of view. But in order to be an all around telescope, it also had to work good visually at high powers, and it had to be a good optical system for astrophotography. We wanted the telescope to be easy to use, portable, reasonably light weight, rugged, and affordable. This telescope needed to fulfill the roles of a solid performing instrument for the serious beginner, the public outreach enthusiast, and beginning to advanced astrophotographers... a telescope that you could use all your life and then be passed on to future generations of would be astronomers.

We discussed a lot of ideas, settling on a six inch (152mm) aperture f/4.8 rich field system. We then selected a rugged Maksutov-Newtonian optical design to give high performance images across the entire field of view over a wide range of magnifications. To obtain wide field views for scanning for comets and observing faint deep sky objects we include a 2" O.D. 70° Series 30mm eyepiece that provides nearly 2.9° true field of view at 24x. The finder scope is a special 8x50 correct view (not upside down and backwards like most finder scopes) so that it is easy to match the view in the finder scope to a star map. To make a worthy telescope for astrophotographers we added a ten-to-one, two-speed focuser, and a carbon fiber tube to eliminate tube expansion problems, both of which allow precision focusing that can hold its focus even with temperature changes at night. The dual cradle rings have a slotted handle on top to allow easy handling and to allow attachment of camera with a standard 1/4x20 bolt. We also included a light-weight carbon fiber dew shield, and a rugged case to protect the instrument.

I never tire of looking through telescopes, but it's not the thrill of making a discovery that keeps me going; Exploring the sky and sharing the experience inspires me to go on to write, lecture, and observe the stars as much as possible. I have always made time to share the experience of stargazing with people of all ages, and these efforts have culminated in the National Sharing the Sky Foundation where we bring the excitement of astronomical exploration to grade schools across the country.

Through a special arrangement with Explore Scientific, sales of this Comet Hunter telescope help support the National Sharing the Sky Foundation so that we can carry on with our outreach activities. So we encourage you to use your Comet Hunter as often as possible and to get involved in public outreach in astronomy in your local community. And if the time ever comes when you wish to retire this instrument, consider making a tax-deductible donation of your telescope to our non-profit organization, where we will make sure that it will serve in educational outreach programs at a public school or planetarium. To learn more about us go to www.sharingthesky.org.

Be sure to fill out the warranty registration of your Comet Hunter, and we will send you a certificate of authenticity with my signature.

Wishing you many starlit nights,

David H. Levy
sharingthesky.org

A Message from Explore Scientific

We wish to thank you for choosing a David H. Levy Comet Hunter 152mm f/4.8 Maksutov-Newtonian telescope! It is quite literally a telescope that was born to share the sky; a portion of each sale goes to the National Sharing the Sky Foundation, a non-profit organization based in Arizona, where David Levy and his staff support schools and the general public around the world in their quest to learn more about science through hands on astronomy.

We hope that you use your Comet Hunter as often as possible and that you seriously consider getting involved in public outreach in astronomy in your local community. If you don't already know, astronomy outreach is a very enriching and rewarding activity where your knowledge and your telescope help to give people of all walks of life a deeper understanding of our place in the universe and greater insight into what all humans have in common.

It was Carl Sagan who said. "*Earth is a very small stage in a vast cosmic arena.*" Just looking up at a star-filled sky humbles most of us, opens our minds, and just with a little astronomical background knowledge confronts us with a profound truth that we are somehow interconnected with the cosmos. With your telescope you can share the experience with friends and family, you'll find that it will be a truly mind expanding experience for them and for yourself.

While sharing the eyepiece of your Comet Hunter to show others the belts of Jupiter, or the faint glow of a distant galaxy is fun and interesting, exposing others to astronomy has many other direct benefits. The very act of contemplating the vastness of the universe lets one experience a feeling of tranquility, and creates some space within to put priorities into perspective. It can motivate young people to pursue careers in technology, medicine, engineering, and mathematics. There are few things more gratifying than opening the minds of others, fostering a sense of wonder, providing greater understanding, and setting them on a never ending journey of learning. Ultimately astronomy can motivate people around the world to support bold programs of exploration and discovery.

Those who encourage others to join in on the adventure of exploring the sky and the universe are engaged in astronomy education and public outreach, and we hope that you too become involved. You can start with a free membership in the Explore Alliance and connect with one of the Alliance Partners. You can learn more by going online to www.explorealliance.org.

Should you have any questions or suggestions for us, please don't hesitate to contact our Customer Service center at (888) 599-7597. We will be happy to help you.

The Team at Explore Scientific

www.explorescientific.com

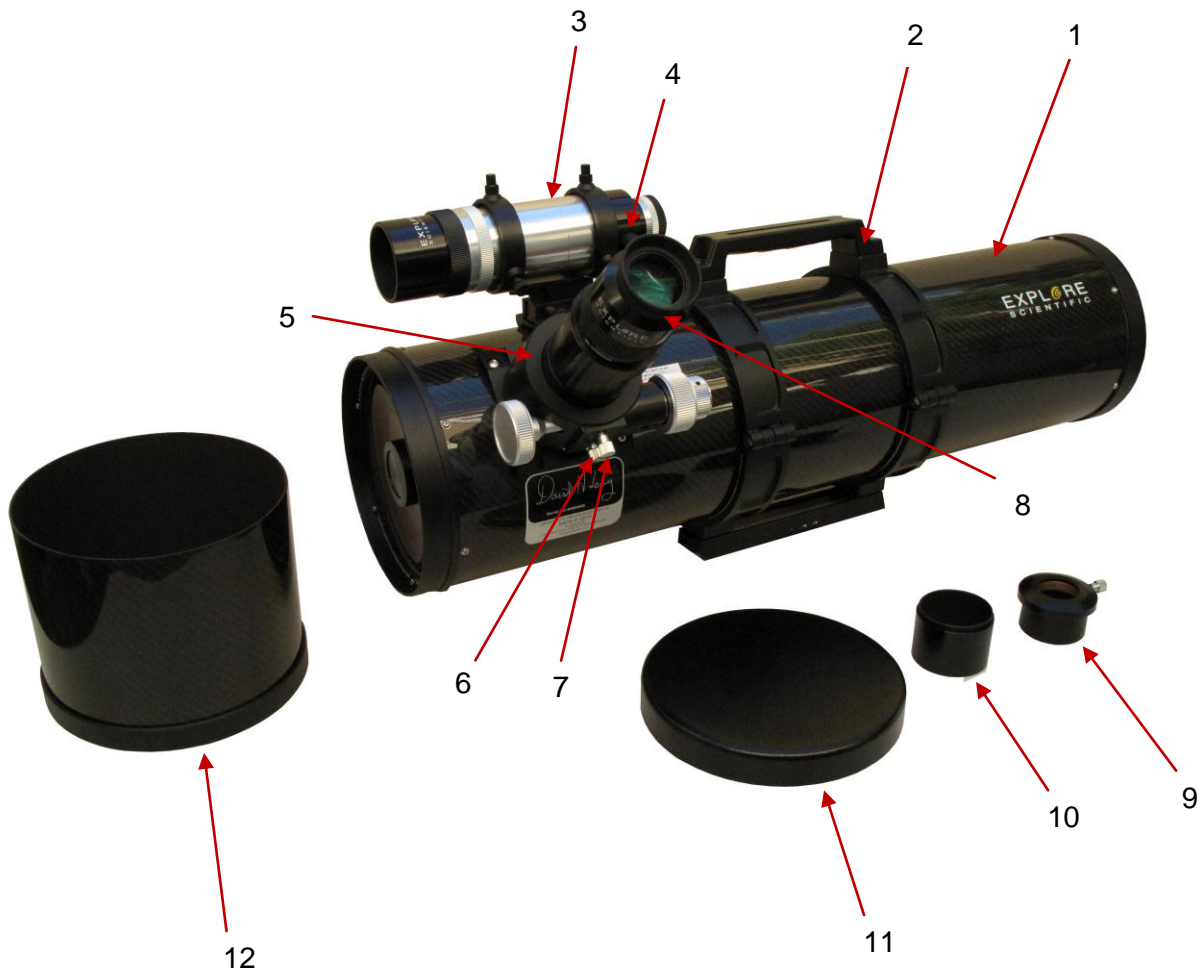

Fig. 1 Standard Equipment

1. Optical Tube
2. Cradle Rings with Handle
3. 8x50 Correct Image Finderscope
4. Finderscope Illuminator
5. 10:1 Two-Speed Focuser
6. Focus Lock Knob
7. Focus Tension Knob
8. 30mm 70° Series Eyepiece
9. 2" to 1.25" Eyepiece Adapter
10. Focuser Extension Tube
11. Front Dust Cover
12. Dew Shield

Getting Started

Focusing the Finder Scope

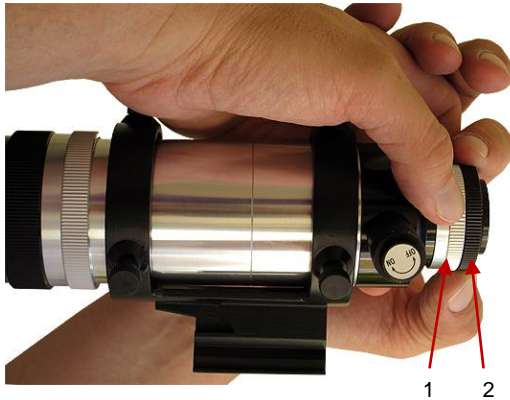

Fig. 2, Eyepiece Focusing

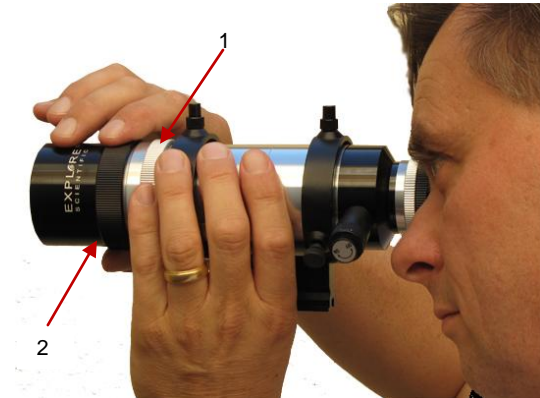

Fig. 3, Objective Lens Focusing

The 8X50 Correct Image Finder Scope has focusing adjustments for the objective and the eyepiece. You can make the initial focus adjustments hand held:

1. Loosen the eyepiece focus adjustment by turning it counterclockwise while firmly holding the eyepiece focus lock ring (1, Fig. 2). Further separate the eyepiece focuser (2, Fig. 2) and the focuser lock ring to allow a good range of adjustment.
2. Aim the finder scope at a blank wall and concentrate your eye on the crosshairs. Turn the eyepiece focuser (2, Fig. 2) left or right until you see the finder scope crosshairs perfectly sharp.
3. Once you have found perfect crosshair focus, turn the eyepiece focuser lock ring (1, Fig. 2) against the eyepiece focuser (2, Fig. 2) until it is snug so that it holds the eyepiece focus position.
4. Loosen the objective lens focus adjustment by turning it counterclockwise while firmly holding the objective lens focus lock ring (1, Fig. 3). Further separate the objective lens focuser (2, Fig. 3), and the focuser lock ring to allow a good range of adjustment.
5. Aim the finder scope at a very distant object (the greater the distance the better) and concentrate your eye on the distant object. Turn the lens objective focuser (2, Fig. 3) left or right until you see the distant object and the crosshairs of the finder scope perfectly sharp.
6. Once you have found perfect focus, turn the objective lens focuser lock ring (1, Fig. 3) against the focuser until it is snug so that it holds the focus position.
7. Repeat this process on a bright star or the Moon, once you have attached the finder scope on the telescope (see below) to get perfect focus adjustment for astronomy.

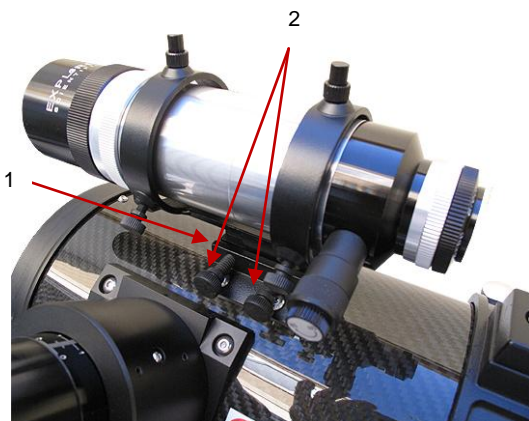

Fig. 3, Dovetail and Attachment Screws

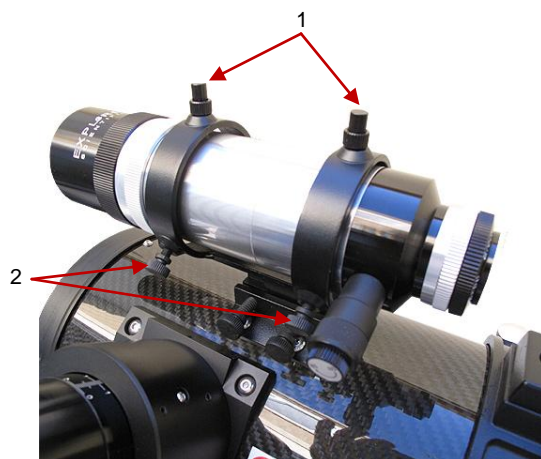

Fig. 4, Finder Scope Adjustment Screws

Mounting and Adjusting the Finder Scope

To align the finder scope, perform steps 1 through 5 during the daytime; perform step 6 at night.

1. Slide the track on the bottom of the finder scope into the slot in the finder scope mounting assembly (**1, Fig.3**). To secure the finder scope to the mounting assembly, tighten the two thumbscrews (**2, Fig. 3**) to a firm feel only.
2. If you have not already done so, insert the 30mm 70° Series eyepiece into the eyepiece holder.
3. Point the telescope at some well-defined and stationary land object at least 200 m distant, such as the top of a telephone pole or street sign. Center the object in the telescope eyepiece.
4. Look through the finder scope eyepiece and loosen or tighten, as appropriate, one or more of the finder scope collimation screws (**2, Fig. 4**) until the finder scope crosshairs are precisely centered on the object you previously centered in the telescope eyepiece.
5. Check this alignment on a celestial object, such as the Moon or a bright star, and make any necessary refinements, using the method outlined in steps 3 through 5.

NOTE: The two screws on the top of the finder scope (1, Fig. 4) are not adjustment screws. They are spring loaded used to hold the finder scope.



Fig. 5, Finder Scope Illuminator



Fig. 6, Illuminator and Batteries

Using the Finder Scope Illuminator

The finder scope illuminator has a continuously adjustable brightness knob with click on and click off positions. To switch the illuminator on, turn the adjustment knob clockwise (**1, Fig. 5**), past the click stop. The illuminator gets brighter as you turn it further clockwise. For best results for astronomy use the illuminator at the dimmest setting that allows you to comfortably see the crosshairs (which will glow red).

The batteries will last several hours of continuous illumination (less in cold weather, more in warm conditions). When not using the finder scope, turn the illuminator off, by turning the knob counter-clockwise past the click stop.

To replace the batteries follow these steps:

1. Unthread the illuminator from the finder scope by grasping the entire unit and twisting it counterclockwise until it is free.
2. Separate the two halves of the illuminator by grasping the two ends (**1 and 2, Fig. 6**) and twisting counterclockwise. Carefully separate the two halves when you feel that the illuminator pieces are free so that the batteries (and the black plastic sleeve that hold batteries) don't fall on the ground.
3. Tip the bottom half of the illuminator so that the batteries and the sleeve (**3, Fig. 6**) drop in your hand.
4. Push the two LR41 (1.5v) batteries out of the plastic sleeve and replace them with fresh batteries so that the positive ends are in series (not facing each other).
5. Replace the batteries with the sleeve in the bottom half of the assembly so that the negative ends of the batteries are facing the LED illuminator.
6. Replace the top half of the illuminator by turning the two halves clockwise until firm.
7. Test the illuminator by switching it on past the click stop.
8. If the illuminator tests okay, then attach the illuminator back on to the finder scope.

NOTE: If the illuminator does not turn on, recheck the battery position for the correct polarity position. If the polarity is correct, test the batteries to make sure that they have a full charge. If the battery polarity is correct and they have a full charge but still do not work, clean the battery terminals by rubbing them with a pencil eraser and try again. If you have further trouble please contact Customer Service.



Fig. 7, 10:1 Two-Speed Focuser

Tools

The Comet Hunter uses standard metric hex wrenches and a flat-head screwdriver to make most of the adjustments. Upon registering the product, our Customer Service department will provide a special primary mirror collimation adjustment tool that allows more precise adjustments, and the ability to hold the final adjustment securely while the mirror cell is locked.

Using and Adjusting the Focuser

The David H. Levy Comet Hunter 152mm f/4.8 Maksutov-Newtonian comes standard with a 10:1 Two-Speed Crayford-Style focuser, which allows for precise focusing.

You can change the tension of the eyepiece holder. Just screw the tension knob (1, Fig. 7) a little bit till you have the preferred focus knob tension.

If you want to lock the eyepiece holder, please tighten the lock knob (2, Fig.7).

If you wish to further change the tension, you can adjust the two sets of three screws on the focuser's top side. The center silver hex screws hold a semi circular plate with four bearings that press on the draw tube. If you loosen the center screws (and the tension control screw), you can adjust the four black hex screws to provide the desired pressure. You need do this in very small increments – too tight and the draw tube will focus roughly and too loose the focuser will not hold position well. After adjustment the center screws should be retightened and tightening the tension control screw will be more aggressive.

Using 1.25" and 2" O.D. Eyepieces:

The Comet Hunter comes standard with a 2" diameter focuser. To use 2" O.D. eyepieces, remove the dust cover, release the eyepiece holder set screw, and slide the eyepiece barrel into the focuser. Tighten the eyepiece holder set screw to secure the eyepiece.

To use 1.25" O.D. eyepieces, slide the 1.25" eyepiece adapter (9, Fig. 1) in the 2" eyepiece holder in the same manner that you would when inserting a 2" O.D. eyepiece, then secure it in place by tightening the 2" eyepiece holder set screw. Then release the 1.25" eyepiece holder set screw and slide in the eyepiece barrel into the adapter. Tighten the 1.25" adapter eyepiece holder set screw to secure the eyepiece.

Using the Extension Tube:

Depending on the focal length of the eyepiece or type of camera that you are using on the Comet Hunter, you may need extra extension of the focuser drawtube to reach focus. The 40mm 2" O.D. focuser extension tube (10, Fig. 1) is supplied as standard equipment for this purpose. To attach it, grasp the eyepiece holder section of the focuser and turn it counterclockwise to free the end of the focuser drawtube. Then thread on the focuser extension tube clockwise and tighten it to a firm feel, then thread on the end of the eyepiece holder section to a firm feel.

The Dew Shield

The Comet Hunter comes standard with a carbon fiber dew shield (12, Fig. 1) that attaches to the front cell of the telescope tube with a friction fit. We advise using the dew shield at all times possible to eliminate stray light and slow the progress of dew forming on the corrector plate.

Note that you can leave the dew shield on when storing in the case, or if the telescope is permanently set up in an observatory, because the front dust cover (11, Fig. 1) fits over the end of the dew shield when the telescope is not in use.

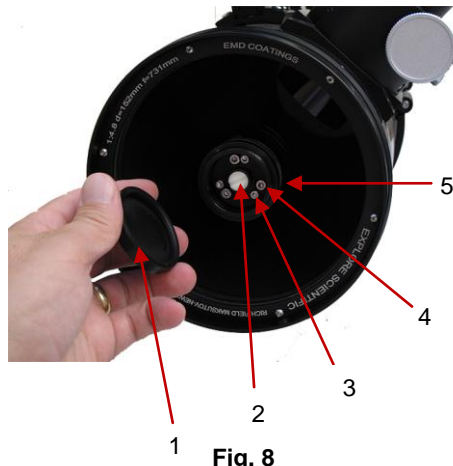

Fig. 8

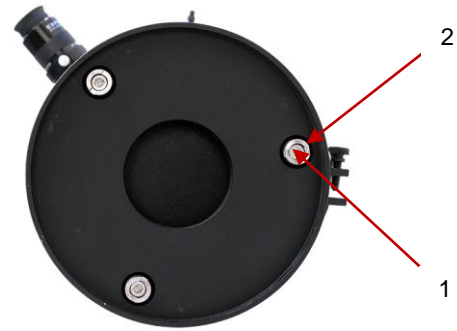

Fig. 9

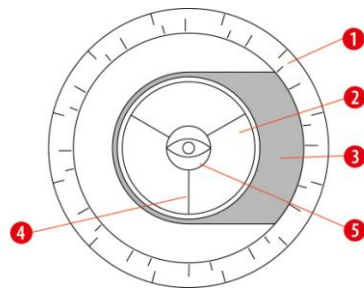

Fig.10

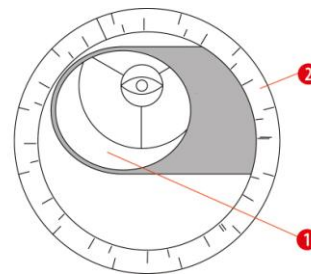

Fig.11

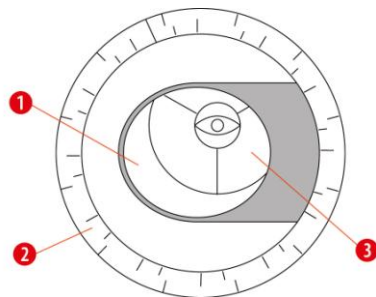

Fig. 12

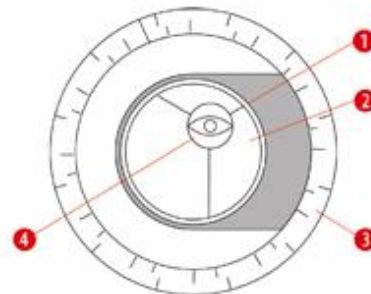

Fig. 13

Collimation

The Comet Hunter telescope is optically aligned (collimated) at the factory prior to shipment, but may occasionally require re-alignment, particularly if the telescope has received rough handling in shipment. Before using this model for the first time, check the alignment of the optics as outlined in this section. Good optical alignment is essential for optimum telescope performance.

Confirm Alignment:

To confirm optical alignment look down the focuser drawtube (1, Fig. 10) with the eyepiece removed. The edge of the focuser drawtube frames reflections of the primary mirror (2, Fig. 10), the secondary mirror (3, Fig. 10), the three (“spider”) vanes (4, Fig. 10) holding the secondary mirror, and the observer’s eye (5, Fig. 10). With the optics properly aligned, all of these reflections appear concentric (centered), as shown in (Fig. 10). Any deviation from concentricity of any of these telescope parts with the eye requires adjustments to the secondary mirror and/or the primary mirror cell, as described below.

Secondary Mirror Adjustments:

There are three types of major adjustment to the secondary mirror: rotation, vertical centering, and tilt. If the secondary mirror (1, Fig. 11) isn't centered in the focuser drawtube (2, Fig. 11), please center it by using the adjustment screws (3 and 4 Fig. 8). to tilt the secondary mirror into place.

If the secondary holder appears centered in the focuser drawtube, but is not rotated to aim the beam of light through the center of the focuser, begin by removing the secondary mirror cover (1, Fig. 8) by grasping it with your hand and turning it counter-clockwise. Then tighten the center flat-head screw (2, Fig. 8) so that it is snug. This screw extends three internal plastic pins that are meant to keep the secondary from rotating while you loosen and tighten the secondary retainer ring (5, Fig. 8). Grasp the secondary retainer ring and turn it counter-clockwise a few turns and then release the center flat-head screw so that the secondary mirror is free to rotate. (Note that your telescope may also have two hex-head set screws in the sides of the secondary retainer ring that must be released in order to free it for unthreading.) With the secondary retainer ring loosened, grasp the secondary assembly and rotate it while looking down the center of the focuser drawtube until the reflection of the secondary mirror resembles the round shape as seen in Fig. 10. Now tighten the center flat-head screw to hold the secondary mirror rotational position, and then tighten the secondary retainer ring until it is snug. Double check the rotational position of the secondary mirror. If the adjustment looks good, then release the center flat-head screw to release pressure on the corrector from the three plastic pins.

Vertical centering of the secondary can be adjusted by raising or lowering the secondary assembly by threading in or unthreading a Phillips-head screw that is under the center flat-head screw (2, Fig. 8). Perfect centering of the secondary mirror will appear as in Fig. 10. To access the Phillips-head vertical centering screw, remove the center flat-head screw by using a wide flat-head screwdriver to unthread it from the secondary holder.

Primary Mirror Adjustments:

If the secondary mirror (1, Fig. 10) and the reflection of the primary mirror (2, Fig. 10) appear centered within the drawtube (3, Fig. 10), but the reflection of your eye and the reflection of the secondary mirror (4, Fig. 10) appear off-center, then the primary mirror tilt requires adjusting, using the adjusting screws of the primary mirror cell (1, Fig. 6). These primary mirror-tilt screws are located behind the primary mirror, at the lower end of the main tube. See Fig. 6. Before adjusting the primary mirror-tilt screws, first loosen the three wide slotted primary mirror lock screws (2, Fig. 6) using the provided collimation tool. Then by trial and error turn the primary mirror hex head tilt screws (which are located inside the wide slot headed screws see 1, Fig. 6) until you develop a feel for which way to turn each screw to center the reflection of your eye in the drawtube. (An assistant is helpful in this operation.) With your eye centered as shown in Fig. 7, turn the three wide slotted head primary mirror lock screws (1, Fig. 6) to re-lock the tilt-angle of the primary mirror. There is interaction between the adjustment and lock screws and it may be necessary to use both locking and tilt screws simultaneously.

The collimation locks will hold collimation for a long period; however, collimation should be rechecked from time to time.

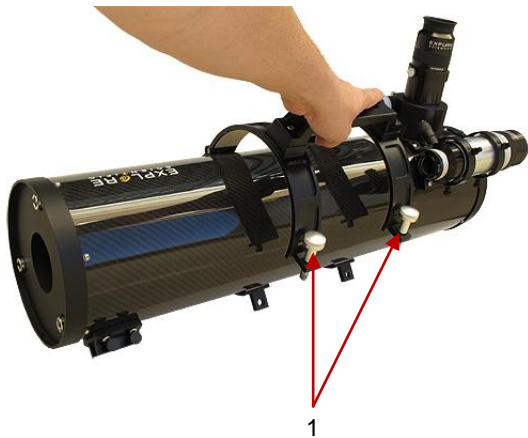

Fig. 14

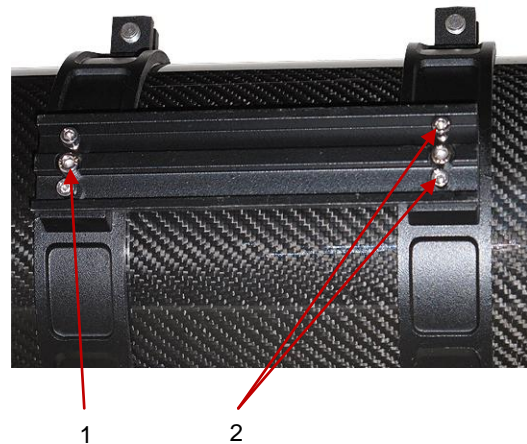

Fig. 15

Cradle Ring Assembly and Dovetail Adjustments

The cradle rings are clamp style that secure and release with a single knob. To make adjustments for tube balance and/or eyepiece position, release the knob on each ring (1, Fig. 14) so that the tube is loose enough in the rings to slide back and forth or rotate. Be careful to hold the tube securely so that you do not lose control of it while the cradle rings are loose. Once the tube is in the desired position, be sure to tighten each cradle ring lock knob until the tube is secure.

The dovetail saddle plate on the Comet Hunter has adjustments for cone error. On the bottom of the saddle plate are three hex screws on each end (1 and 2 Fig. 15). The center screw (1, Fig. 15) holds the dovetail to the cradle ring, the two outer screws (2, Fig. 15) allow for cone error adjustment.

Cone error adjustment is most often used when the telescope is attached to a German equatorial mount, so that the polar axis of the mount and the center of the telescope's optical axis are aiming at the same point in the sky. Adjustment is done by trial and error. Typically on an alt-azimuth mount, no such adjustments are necessary.

Note that when the final adjustments are made to the screws, that the center screw (**1, Fig. 15**) must have enough purchase into the threads of the cradle ring so that it does not lose contact, and the two outer screws must be tightened snug enough to eliminate any looseness of the dovetail saddle plate to the cradle rings.

Cleaning and Taking Care of the Comet Hunter

All telescope optics are subjected to some dust and dirt as they are intended to be used outdoors. Indeed even if the optics are pristine from particles that you could see with the naked eye, it will be quite impossible to keep any telescope optics free from dust as you use it. Experience will show you that a few particles on any optical surface (inside or out), as they will not affect visual or photographic performance. But there is a point when optics can become uniformly dirty and it will affect image contrast.

As with any fine piece of optical equipment, do your best to prevent exposure to dust and moisture. This will reduce how often you will be required to clean the optics. This advice is not only for when the telescope is being used in the field, but when the telescope is stored in its case.

Use the supplied dew shield as often as possible, as it will help to protect the Maksutov corrector plate from the elements. The dew shield not only prevents dew from forming, and dust from settling on the corrector plate lens, it prevents stray light from reducing image contrast. Although the dew shield will greatly aid in moisture buildup, it can still occur during nights when dew conditions become severe. Wet optics are not harmful to the telescope, but the instrument should not be packed away in its case until the moisture has completely evaporated. You can accelerate evaporation with a hair dryer or just by setting up the telescope in a dry environment with the dust covers removed. Packing the telescope away in its case when it is wet will result in a steam bath environment, which can allow mold and fungus to grow on the optics.

Never attempt to wipe down optics that are covered with dew with a dry cloth, tissue, or cotton ball, as dust and dirt may be trapped in the moisture, which will scratch the optics when you attempt to wipe it clean. Dry the optics first and then follow the cleaning procedure if necessary. Often you will find the optics still in fine condition after the dew has evaporated and will not require cleaning.

If you live in a very moist climate, you may find it necessary to use silica desiccant stored in the telescope's case to ward off moisture and the possibility of fungus or mold growing on and within the coatings of the optics. Replace the desiccant as often as necessary. Those living in coastal areas or tropic zones should consider applying a water displacement solution on the metal surfaces of the telescope (being careful not to apply it to the optics).

A thick layer of dust will attract and absorb moisture on all exposed surfaces. Left unattended, it can cause damaging corrosion. To keep dust at bay when observing outdoors, the telescope can be set up on a small section of indoor/outdoor carpet. If you are observing for more than one night in a row, the telescope can be left set up but covered with a large plastic bag. Eyepieces and other accessories are best kept in plastic bags with silica desiccant and stored in cases.

All of the non optical surfaces of the Comet Hunter should be cleaned occasionally with a soft rag to prevent corrosion. The cast metal surfaces and the individual exposed screws can also be kept looking new and corrosion free by wiping them down with a water displacement solution (such as WD-40). Take care not to smear the solution onto the optical surfaces, and to wipe up any excess solution with a clean, dry, soft cloth. The carbon fiber tube can be polished with a liquid car polish and a soft polishing cloth.

Regular Optical Cleaning:

It never hurts to use filtered, compressed air on your optics, or to use a photographic-grade camel hair brush. Indeed you will find that most professional photographers will double check the optical surfaces and give them a quick dusting before using their cameras, you can do the same when you use your telescope.

You can use canned, compressed air as found in camera stores. Be careful not to tip the can, because frozen propellant will come out and leave a layer on your optics that will then require cleaning with fluid and tissues or cotton balls. Start by giving a few quick bursts on your hand to make sure that only air is coming out, then with the can held vertical give a few quick bursts of air to remove dust. If you have an air compressor, use two in-line filters to prevent spraying oil on your optics. Another alternative is to use an ear syringe (available from a local pharmacy) to blow off dust. The ear syringe does not have the force of compressed air, but it doesn't have the problems of compressed air, and it never requires to be refilled.

Stubborn dust particles can be removed with a photographic-grade camel hair brush. They come in different sizes, depending on the size of the optics that you will want to clean. Only use very gentle brush strokes on the optics and follow up by blowing off the dust with compressed air or the ear syringe.

If brushing and blowing off the dust on your optics does not clean them, then it is time to use cleaning fluids. You will know that the optics will require further cleaning, if they appear to be hazy, have fingerprints, or other buildup of pollens, tree resins, grease, etc.

Explore Scientific offers a professional cleaning and collimation service if you wish, but it is helpful to know how to clean the optics yourself. In this instruction, we give you all of the cleaning agents that we use in regular optics production, how to prepare them, and how to use them. Below is a list of materials that you will need to get started:

- 4 Spray Bottles
- White, Unscented, Lotion-Free Facial Tissue, or White Cotton Balls (avoid cleaning cloths)
- Pure Cotton Swabs
- Distilled Water
- Pure Isopropyl Alcohol (94% or better)
- Dishwashing Liquid Detergent Free of Phosphates with Biodegradable Anionic Surfactants
- Acetone

Prepare the Spray Bottles and Label them Accordingly:

- Pure Distilled Water Only (for suspending stubborn dust and dirt, and rinsing after using cleaning mixture)
- Pure Isopropyl Alcohol Only (a solvent that can dissolve some contaminants, alcohol will not affect paint or plastic surfaces)
- Acetone Only (a more effective solvent that will dissolve almost any contaminant on the glass)
- Cleaning Mixture (for cutting through grease, fingerprints, etc.)

Cleaning Mixture Formula:

Mix three parts of distilled water to one part of pure isopropyl alcohol. Then add a single drop of biodegradable dishwashing liquid detergent per half liter (or pint) of mixture.

Notes On Cleaning:

Before attempting to clean an optical surface with a liquid solution, it is very important that as much dust as possible is removed by using forced air and/or gentle strokes with a photographic grade camel hair brush. This is done to try to eliminate the problem of accidentally grinding the optical surface with grits of dust as you start cleaning with the tissues or cotton balls and liquids.

Be careful of using so called optical lens cleaning tissues as many of them contain fiberglass to reduce the problems of lint. The fiberglass fibers can be abrasive to optics. You can always remove lint, but you can't remove abrasions.

When using tissue or cotton, use short, gentle strokes. Don't apply pressure, just let it touch the surface and wipe in a straight line, don't make circular motions. After each stroke replace the piece of tissue or cotton, or use an unused surface with each stroke. This way you are removing contaminants instead of just spreading them over the optical surfaces.

If you are cleaning small optical surfaces, you can roll the tissue into a small wand, use a cotton swab alone, or use a tissue wrapped cotton swab, depending on the need and your preference.

For cleaning large optical surfaces with distilled water, isopropyl alcohol, or the cleaning mixture, tissues can be made into pillows by opening a sheet, then placing a crumpled sheet in the center, then pulling the four corners of the opened sheet around the crumpled one. This gives you a smooth pillow surface that you can vary in size depending upon the surface to be wiped.

For cleaning edges, or when using acetone, fold the tissue into points, or squares as needed.

When using liquids (with the exception of acetone), it is important that you apply enough solution to wet the optical surface, but not so much that it can seep around the edges and run in between lens elements, such as on multi-element optics (e.g. refractors and eyepieces).

In all cases, the cotton balls or the tissue that you are wiping with should have the liquid applied first to wet its wiping surface.

CAUTION: Alcohol and acetone are extremely flammable, so take appropriate safeguards when using, handling, or storing these liquids. Do not eat, drink, or smoke when using these materials, and wear protective gloves and eyewear (do not wear contact lenses). Always use in a ventilated area. Young children should never attempt to prepare, handle, or use these materials, and older youth (12 and up) should never do so without informed adult supervision. For more information and MSDS data visit <http://hazard.com/msds>.

Cleaning Procedure:

1. Once you have removed as much dust and dirt from the optics as possible with forced air and the camel hair brush, apply Straight Distilled Water to the optical surface and the cotton balls or tissue pillow to help lift off stubborn dust and dirt particles. Apply no pressure to the wiping surface and use a new wiping surface with each wipe. With the optics still wet follow step 2.
2. Use Straight Isopropyl Alcohol using the same technique as above. If there are no other contaminants on the optical surfaces, you will see the optics come clean and dry. If you see streaks or smudges, then follow steps 3 and 4.
3. Use the Cleaning Mixture with the same wiping technique as in step 1, then follow up with step 2, then to step 4.
4. Use the tissue squares and spray Acetone on the wiping surface.

Specifications

Optical design:	Maksutov-Newtonian
Diameter (primary mirror):	152 mm (6")
Diameter (secondary mirror):	46 mm
Obstruction:	49 mm
Focal length:	731 mm
Focal ratio:	f/4.8
Resolving power:	0.74 arc seconds
Material (primary mirror):	BK-7
Coatings:	Enhanced Multi-Layer Deposition (EMD™) Coatings on Primary Mirror and Corrector Plate; 99% Dielectric Coating on Secondary Mirror
Weight (net):	7.3 kg
Length:	690 mm
Diameter (tube):	177 mm



© 2009 Explore Scientific™ - BRESSER®

A JOC Company

7401 Katelyn Ct. Suite A • San Diego, CA 92120 • USA

Tel. +1 (888) 599-7597 • Fax +1 (888) 877-7248 • www.explorescientific.com

Rev. 1.1

Part No. UG-CH102009